

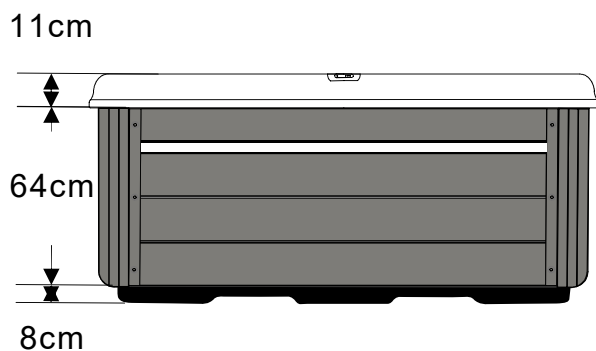

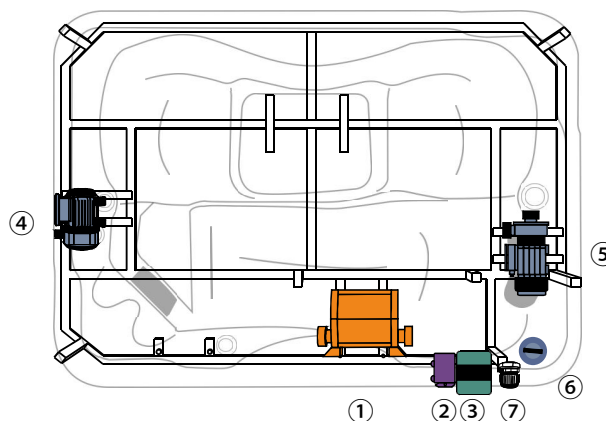

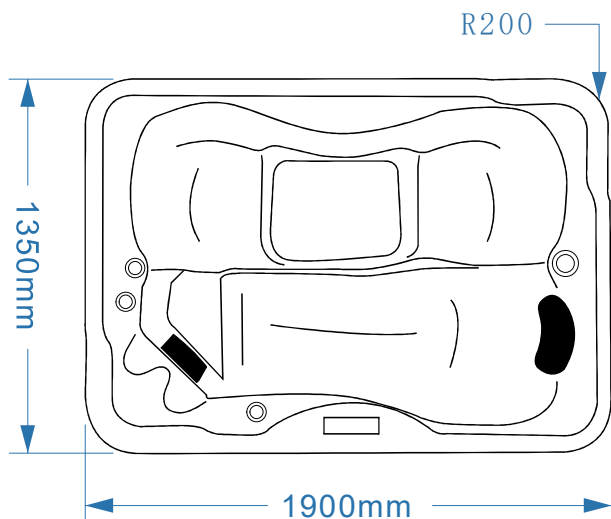



















# GYALI



No.	Items	Part n°
①		Controller Balboa BP200G1
②		Synchronizer KLEDS-4(new one)
③		Ozone KOZG-1
④		SPA circulation pump(WTC50M)
⑤		Massage the water pump(LP200)
⑥		Drain water
⑦		PG head

# GYALI



N°	Description	Ref.	Mark	Qty	Unit	N°	Description	Ref.	Mark	Qty	Unit
1	50# jet	KJ-50#		26	PCS	10	Waterfall	KWF-2		1	PCS
2	Jet 3.5" direct	KJ-3.5		1	PCS	11	speaker	KSspeaker 7		2	PCS
3	Jet 3.5" rotating	KJ-3.5R		4	PCS	12	suction	KRV-2		2	PCS
4	Ozone jet	KOZJET		1	PCS	13	Underwater light	KLED-3		1	PCS
5	Koutlet circulate	KOUTC		2	PCS	14	Small LED light	KLED-5		10	PCS
6	water diverter	KSV-1 New		1	PCS	15	Control panel	TP500		1	PCS
7	air diverter	KSV-3 New		1	PCS	16	Filter cover	KCTC-7		1	PCS
8	fountain diverter	KSV-2 New		2	PCS	17	New BE SPA Pillow	KP-9		1	PCS
9	Pop-up fountain	KFC-2		2	PCS						